



**Alumil**  
Building excellence every day



 **SMARTIA**  
S61

AT ALUMIL,  
WE ARE BUILDING  
EXCELLENCE  
EVERY DAY.

THROUGH OUR STATE-OF-THE-ART FACILITIES AND RIGOROUS QUALITY CONTROLS ACROSS THE ENTIRE PRODUCTION LINE, WE ENSURE THE CREATION OF HIGH-QUALITY, VALUE-ADDED PRODUCTS. OUR CONTINUOUS RESEARCH AND DEVELOPMENT DRIVE THE DELIVERY OF UNIQUE SOLUTIONS WITH INNOVATIVE FEATURES THAT MEET THE DIVERSE NEEDS OF OUR CUSTOMERS.



# CONTENTS

## SMARTIA S6 1

---

OVERVIEW	<b>02</b>
KEY FEATURES AND TECHNICAL CHARACTERISTICS	<b>04</b>
WORTH NOTICING	<b>10</b>
ENERGY OPTIONS	
SYSTEM'S SEALING	
LOW THRESHOLD TYPOLOGIES	
PATIO DOORS	<b>12</b>
INTRO	
BOTTOM CONFIGURATION OPTIONS	
HARDWARE VARIETY	
SECTIONS	<b>18</b>
INSTALLATIONS	<b>32</b>
APPLICATIONS	<b>35</b>
PERFORMANCE	<b>36</b>



▶ SMARTIA  
S61

THE FUTURE OF MODULAR  
HINGED SYSTEMS.

SMARTIA S61 is the latest addition to ALUMIL's hinged systems portfolio, featuring a modular design that enables flexible configurations and a wide range of applications.

Whether for a contemporary boutique hotel or a sophisticated apartment complex, SMARTIA S61 is designed to meet the demands of modern architecture.



SMARTIA S61 is a sophisticated, thermally-insulating hinged system that combines modern design with exceptional performance.

Its modular structure allows for flexible configurations, making it ideal for both residential and commercial applications. From stylish windows to seamless patio doors, SMARTIA S61 enhances any space by combining functionality with contemporary aesthetics, creating a seamless connection between indoor and outdoor environments.

### KEY BENEFITS

- Basic system depth: 61 mm.
- Three energy-efficient options offer versatile solutions for enhanced insulation and reduced overall energy costs.
- Significant sound reduction thanks to triple glazing up to 52 mm.
- Enhanced aesthetics and accessibility with a low threshold of 14 mm.
- High safety using multi-point locking mechanisms.
- Ideal for both new constructions and renovations, as it fully meets the criteria for household energy upgrade programs.



### SPECS

- MINIMUM ALUMINIUM FACE WIDTH**  
93 mm
- FRAME HEIGHT**  
51 / 57.5 / 61 / 71 mm
- FRAME WIDTH**  
61 mm
- SASH HEIGHT**  
73 / 107 / 110 mm
- SASH WIDTH**  
69 mm
- MAXIMUM SASH WEIGHT**  
UP TO 180 KG
- GLAZING INFILL**  
UP TO 52 mm
- INSULATION**  
24MM GLASS REINFORCED POLYAMIDE



## WORTH NOTICING

### ENERGY OPTIONS

By selecting from a range of accessories, SMARTIA S61 offers flexibility in terms of thermal efficiency, improving insulation performance and reducing overall energy costs.

	STANDARD	ADVANCED	HIGH
1 GLAZING GASKETS	●	●	●
2 INSULATION FOAM		●	●
3 INSULATION BARS			●

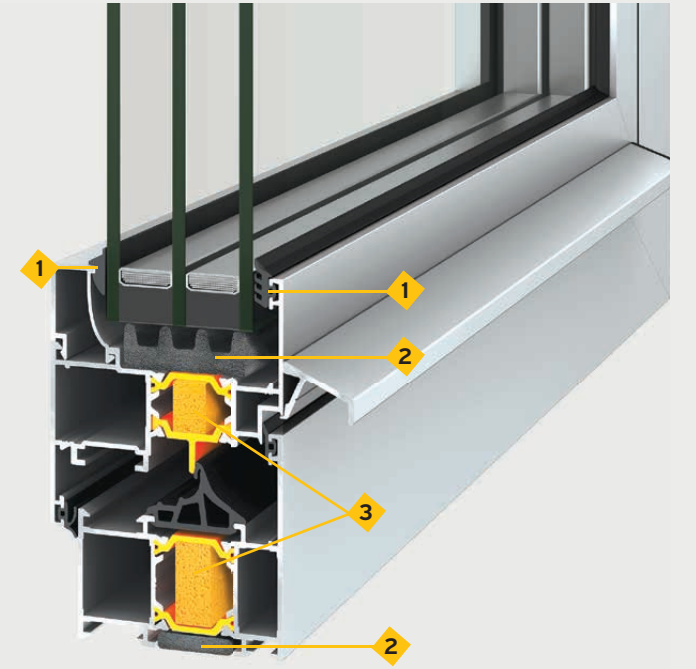

### LOW THRESHOLD SOLUTIONS

Low bottom frame option for balcony doors offering significant benefits in terms of accessibility, design aesthetics, convenience, and performance, making them a practical and stylish choice for modern homes and buildings.

SOPHISTICATED DESIGNED GASKETS GUARANTEE THE SYSTEM'S EFFICIENT WATERPROOFING



## WORTH NOTICING

### SYSTEM SEALING

Three levels of sealing to ensure:

- IMPROVED ENERGY EFFICIENCY,
- WEATHERPROOFING
- NOISE REDUCTION
- INCREASED DURABILITY

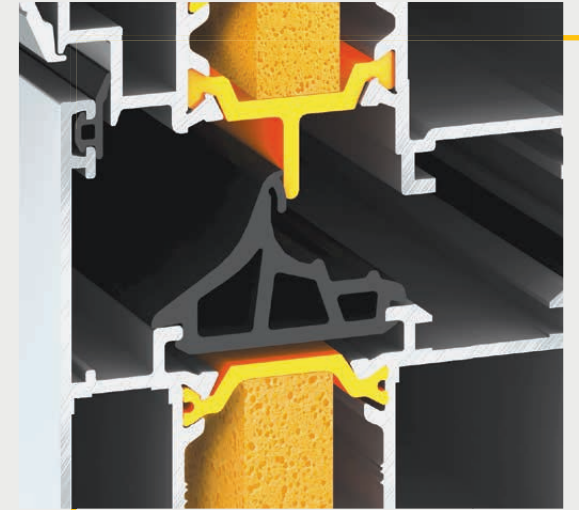

EPDM central gasket, which serves as the primary barrier between the window frame and the sash, helping to block air and water infiltration. This enhances the overall weatherproofing of the system, preventing the leaks.



EPDM two-wing gasket that creates a tight seal between the sash and the frame when the window is closed. This prevents air and water infiltration, keeping the interior protected from external weather conditions such as rain, wind, and temperature fluctuations.



EPDM single-wing gasket that acts as an additional protective seal between the frame and the sash.



**SMARTIA**  
S6 1

**PATIO DOORS**

**FLEXIBILITY, MODULARITY AND  
FUNCTIONALITY AT ITS BEST**

The SMARTIA S61 system provides a comprehensive solution for modern residential and commercial buildings. In addition to windows, it supports functional and stylish patio doors, seamlessly connecting indoor and outdoor spaces while enhancing the overall aesthetic of the home.

With its versatile range of configurations, SMARTIA S61 patio doors are an ideal choice for everything from contemporary villas to office complexes, offering both functionality and modern design.



## BOTTOM CONFIGURATION OPTIONS

System versatility offers three distinct bottom configuration options for patio door typologies.



ADDITIONAL PROFILE  
WITHOUT THRESHOLD



WINDSHIELD  
OPTION

## HARDWARE OPTIONS

### LOCKING OPTIONS

SMARTIA S61 offers high security with multi-point locking mechanisms, available in a wide variety of options.



LOW THRESHOLD  
**14 mm**  
FOR IMPROVED  
ACCESSIBILITY



## HANDLES

The standard door handles, featuring ALUMIL's patented design, are available in a wide range of colors. In addition, the system offers fixed stainless steel door handles, combining both elegance and functionality.



## HEAVY DUTY HINGES

Designed to support larger and heavier doors, they are built to withstand frequent use and resist wear over time. Available in double and triple editions able to withstand up to 150 kg/sash.

Antiburglary fittings and 3D adjustments contribute to system's longevity and credibility.



IMPROVED AESTHETICS BY USING CONCEALED HINGES, PROVIDING A CLEAN, MODERN LOOK WITHOUT VISIBLE HARDWARE DISRUPTING THE DESIGN.

# FIXED

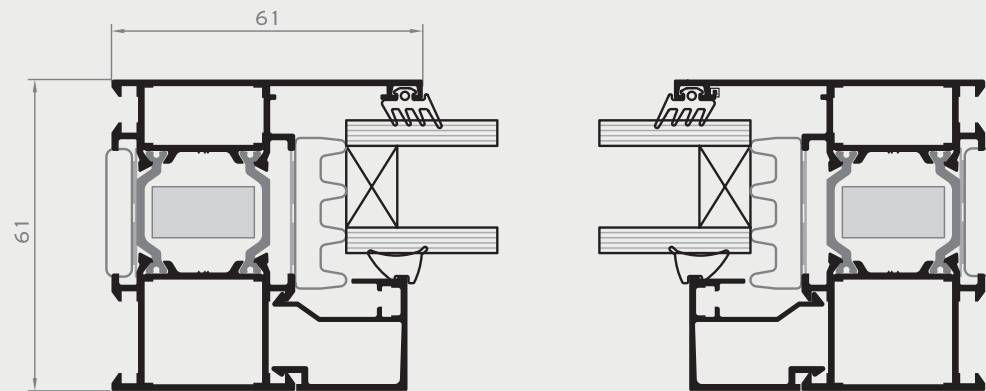
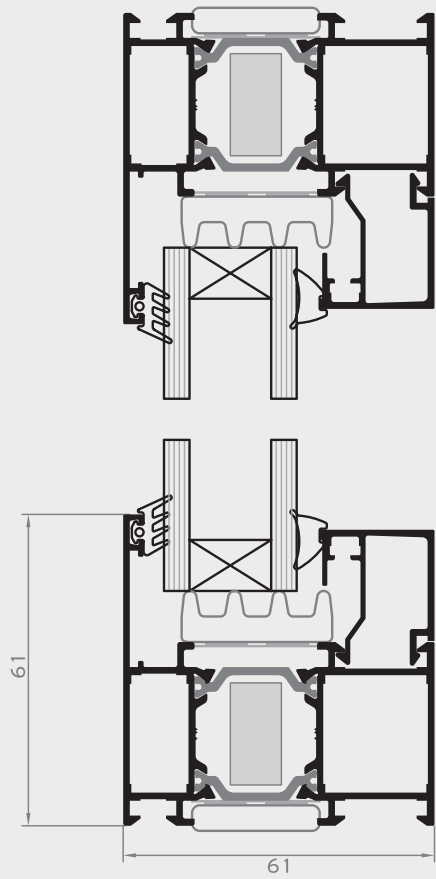
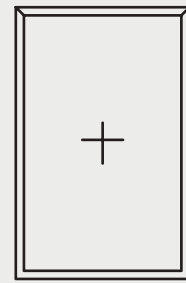

# 1-SASH

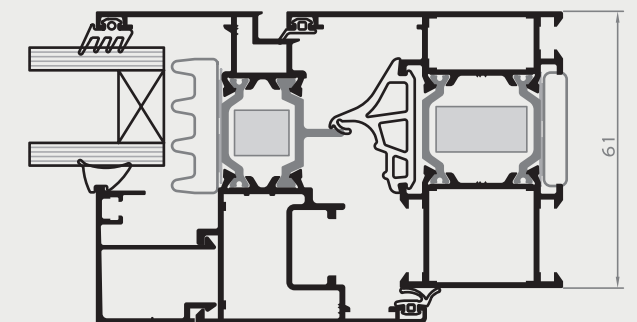
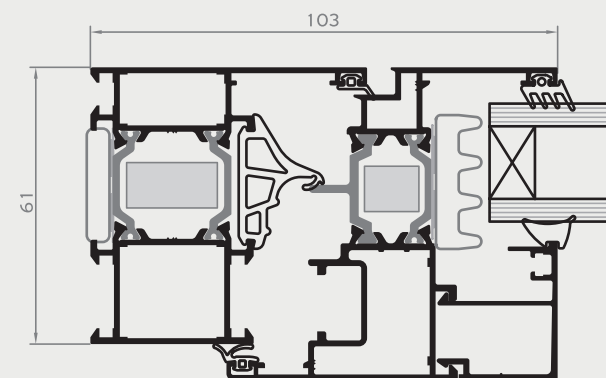
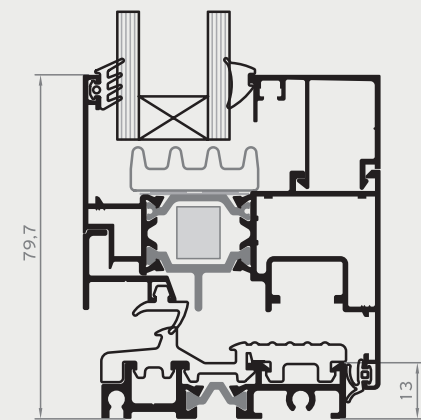
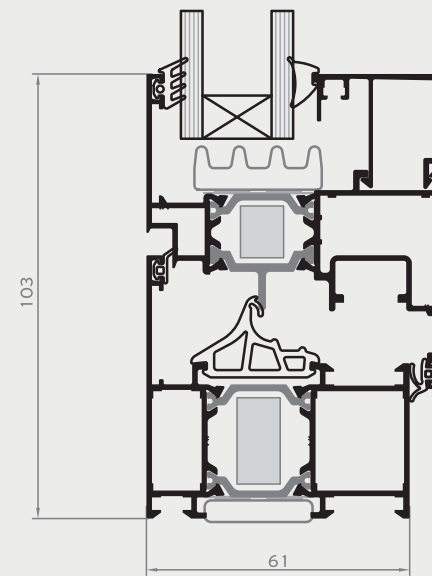
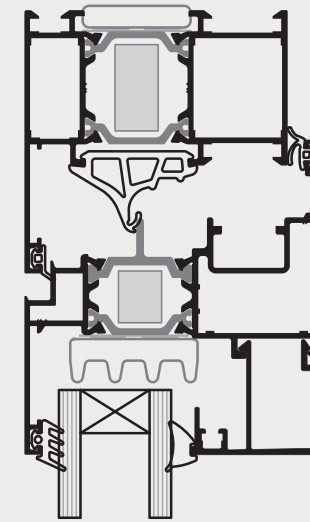
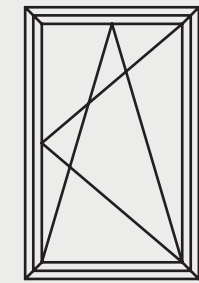

# 2-SASH

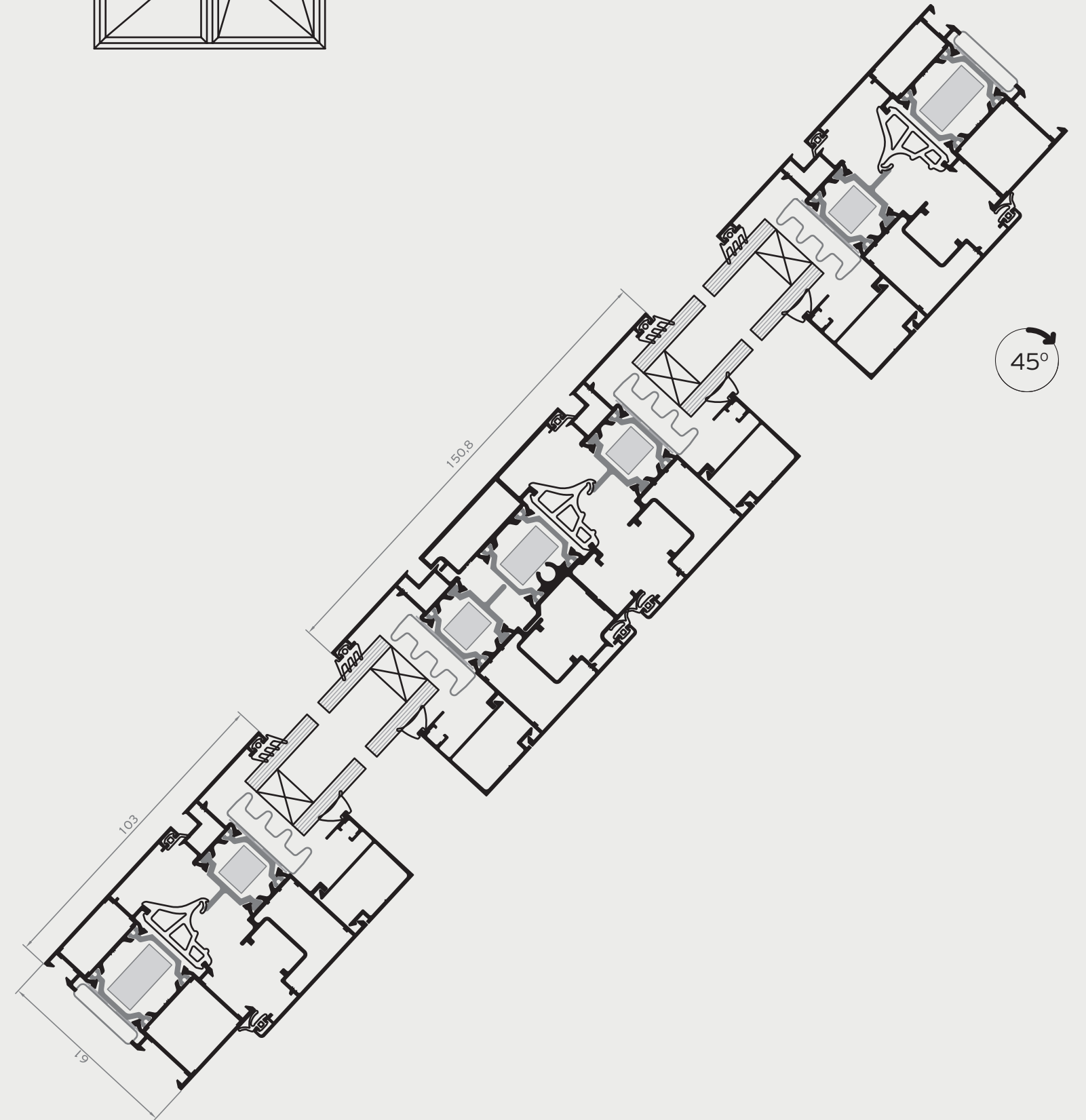
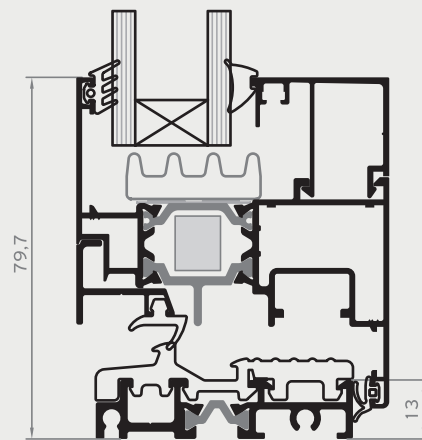
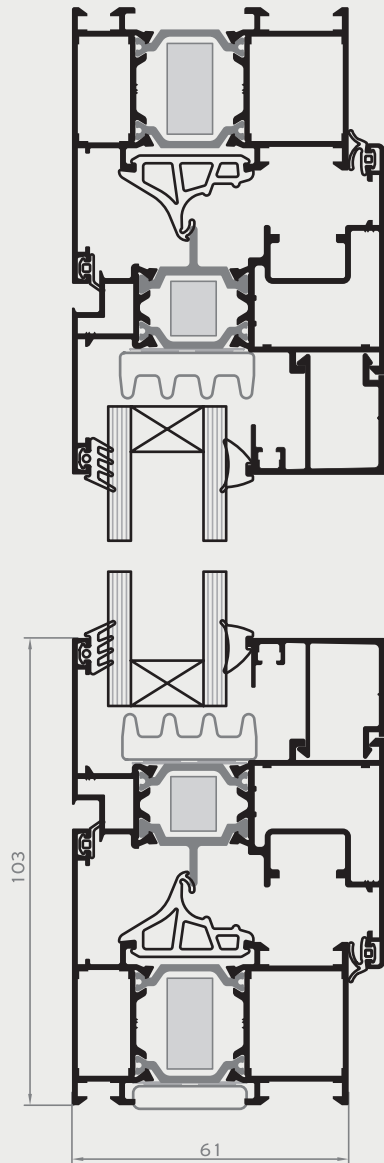
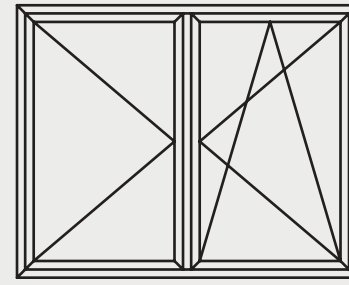

# 1-SASH WITH FIXED

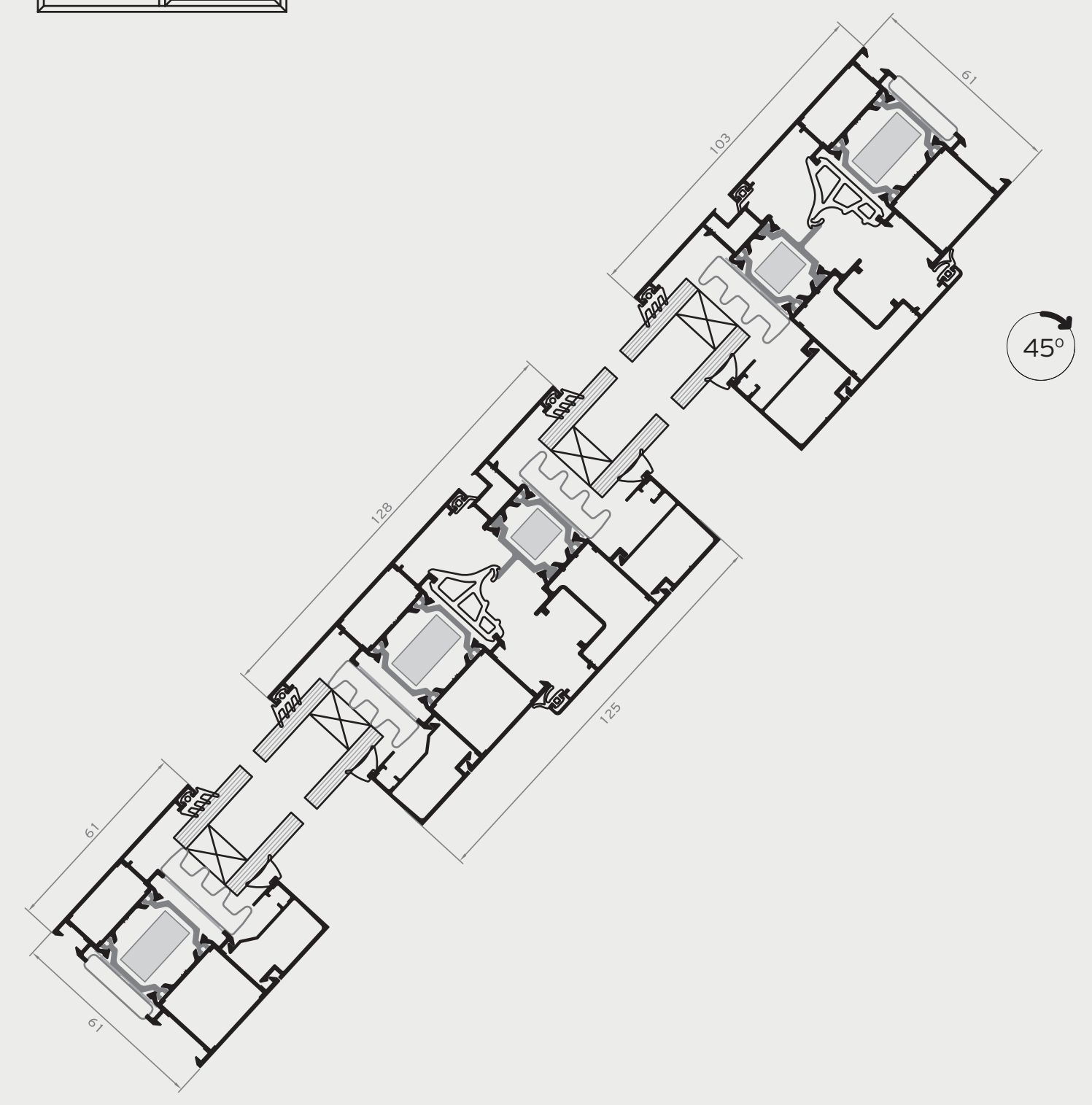
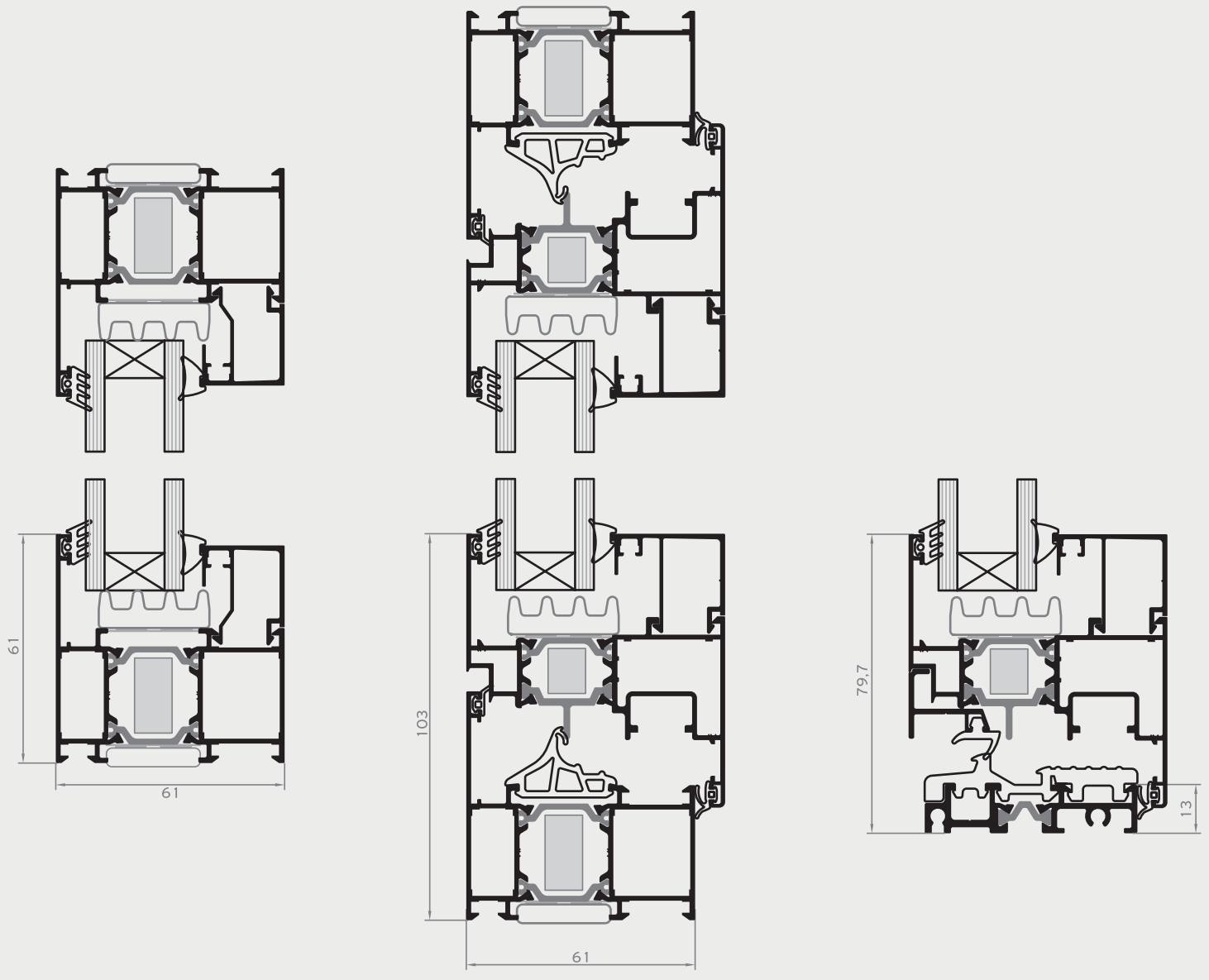
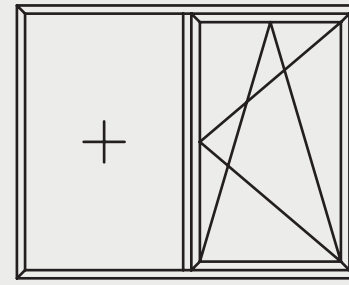

# 1-SASH WITH FIXED LIGHT

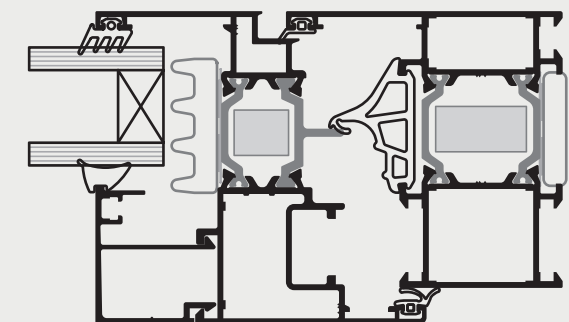
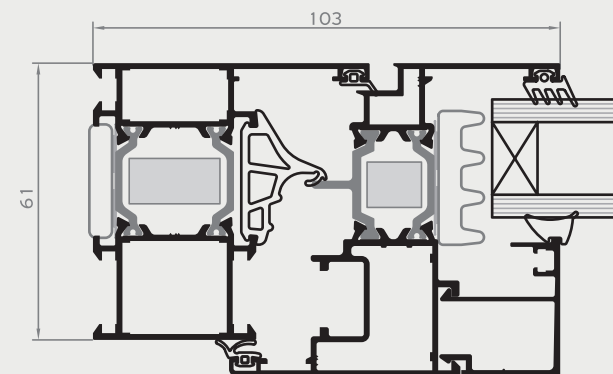
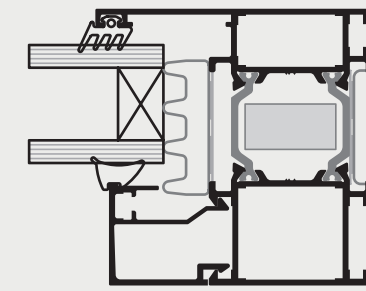
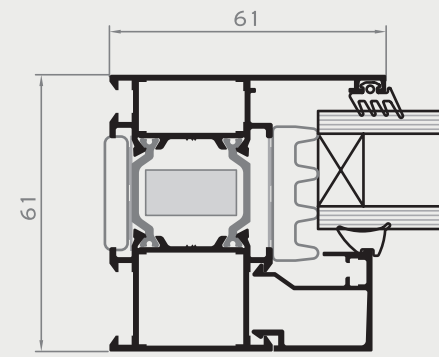
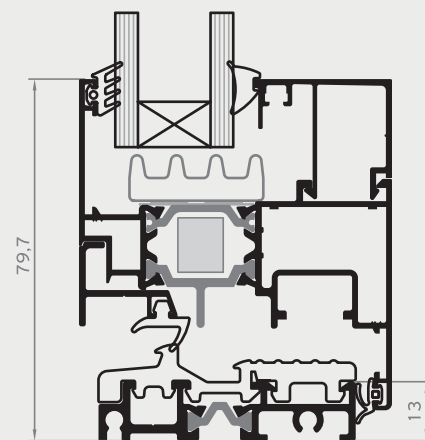
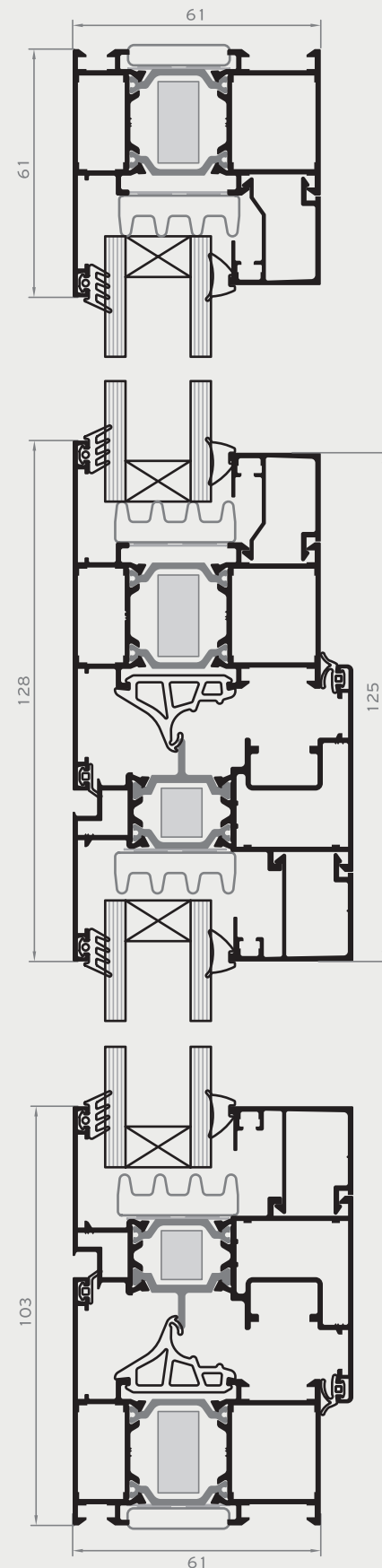
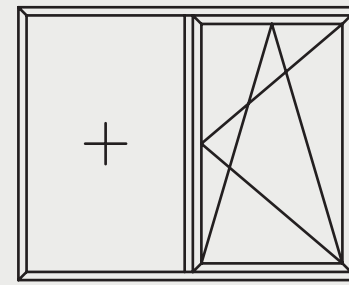

# 1-SASH DOOR INWARDS

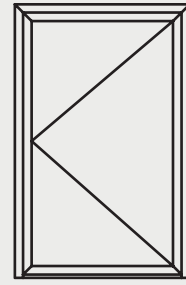

# 1-SASH DOOR OUTWARDS

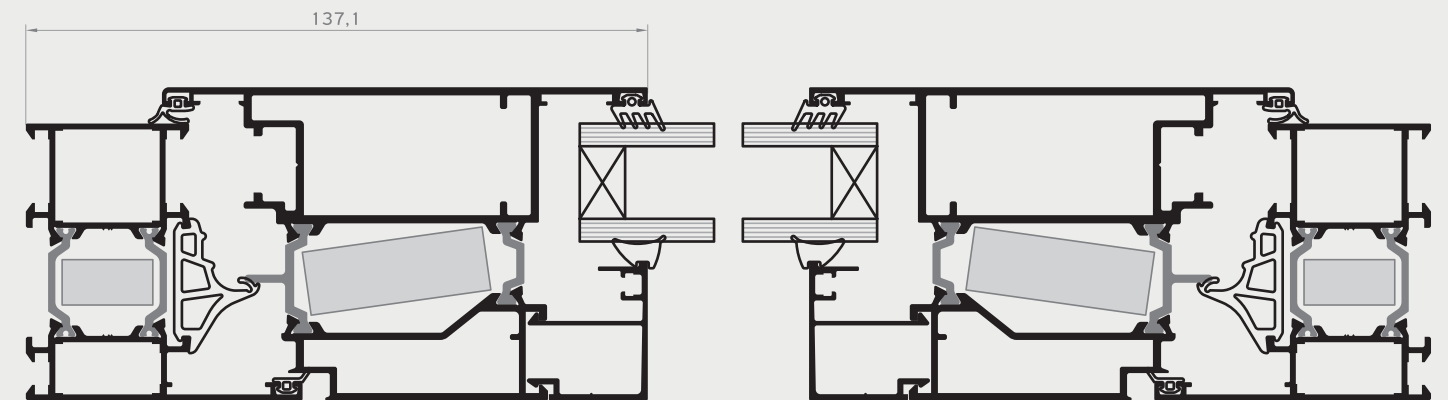
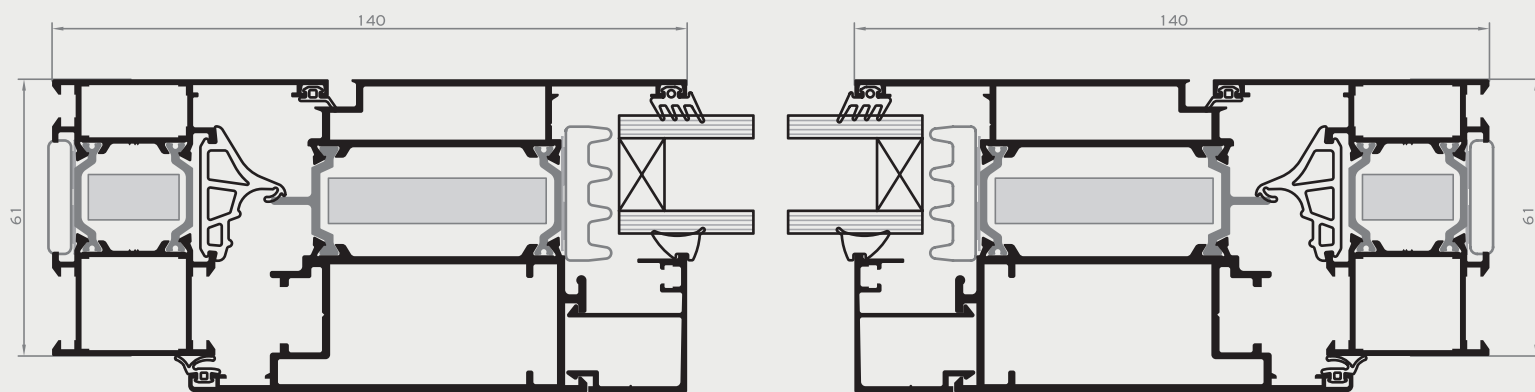
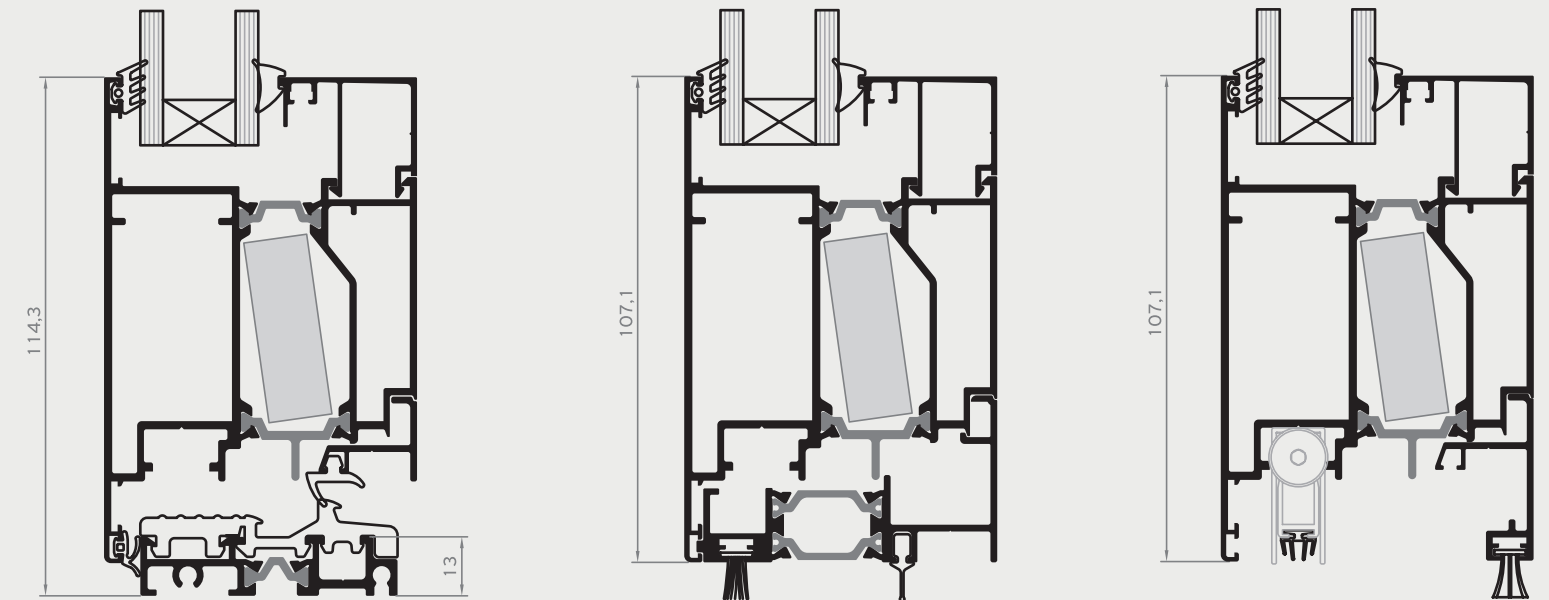
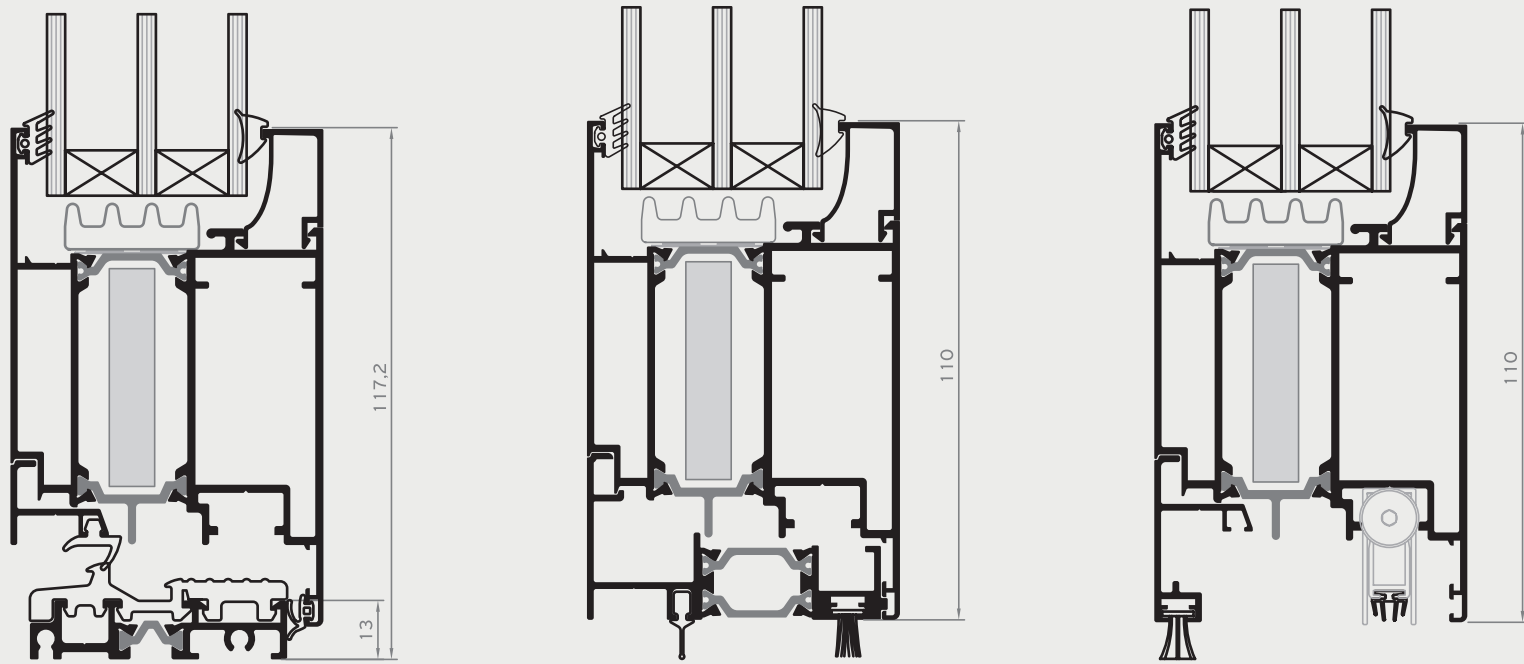
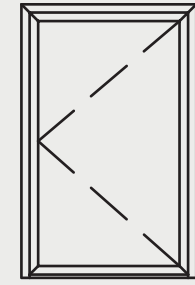

# 2-SASH DOOR INWARDS

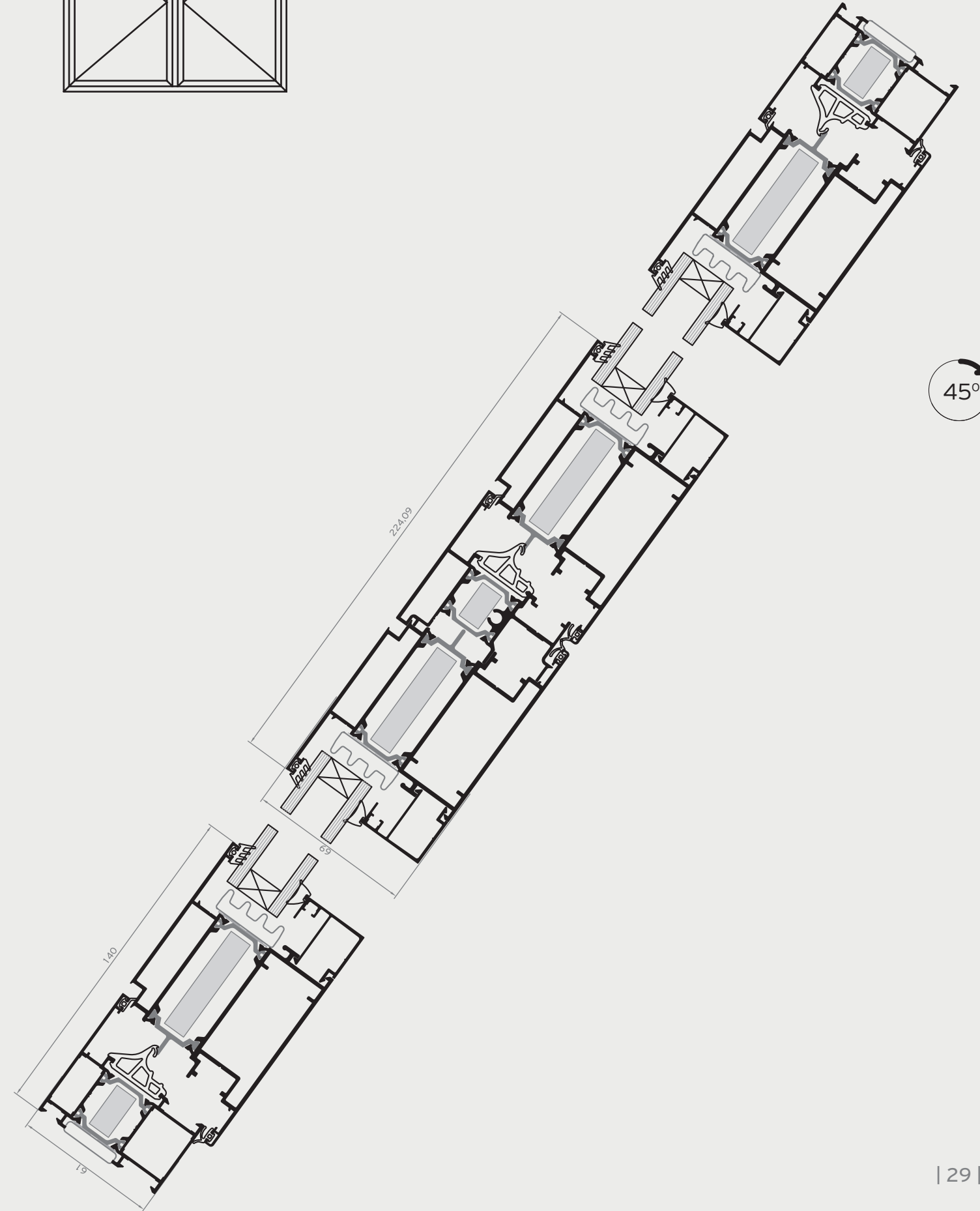
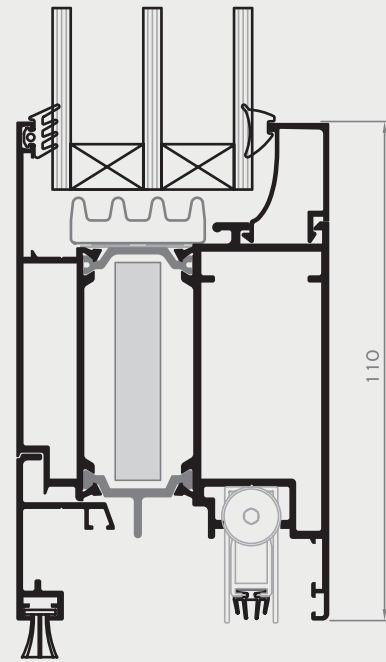
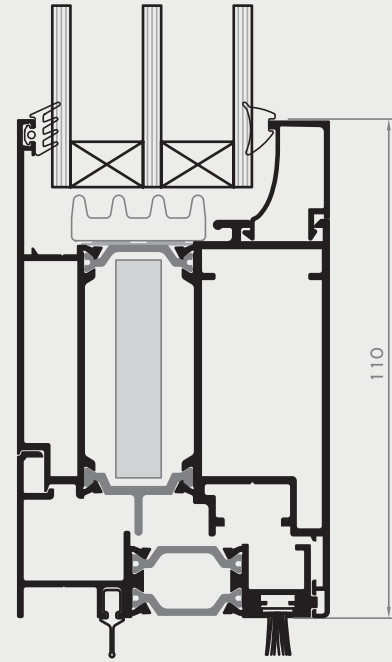
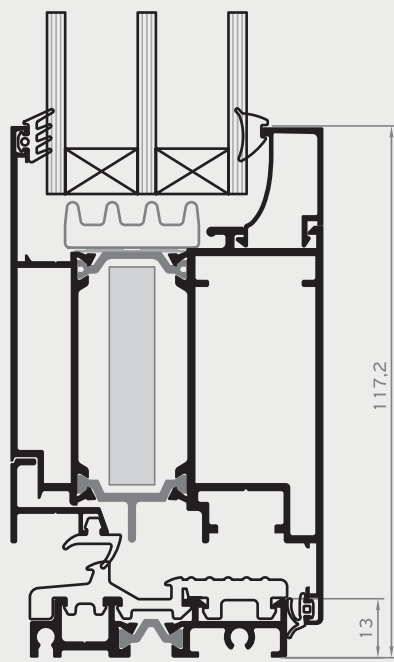
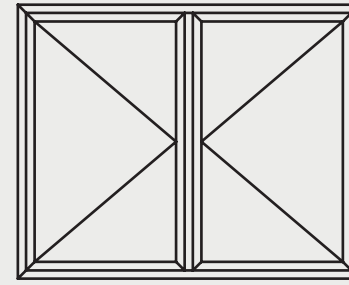

# 2-SASH DOOR OUTWARDS

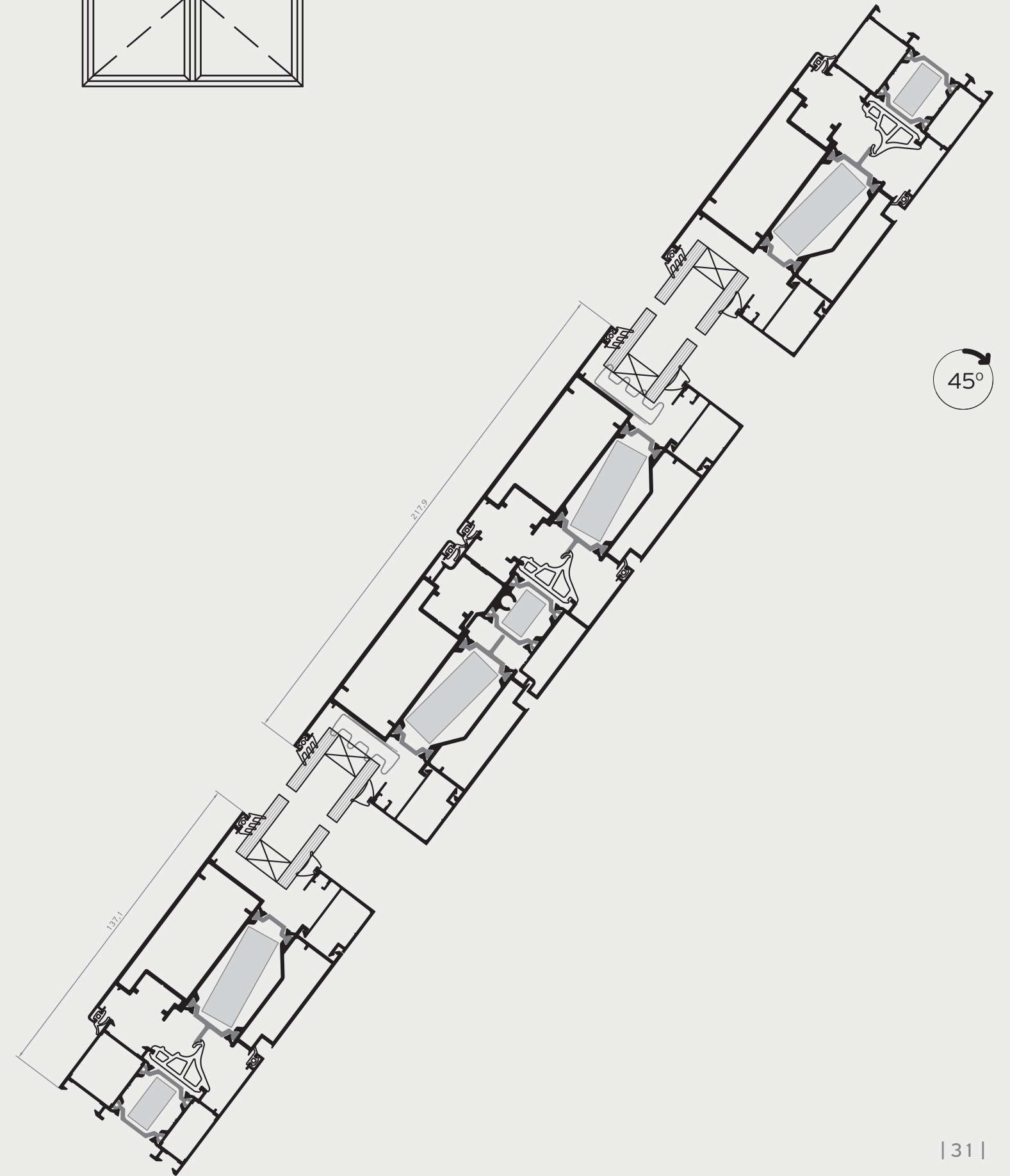
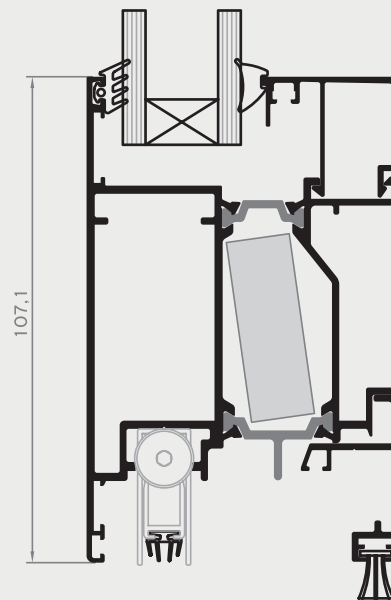
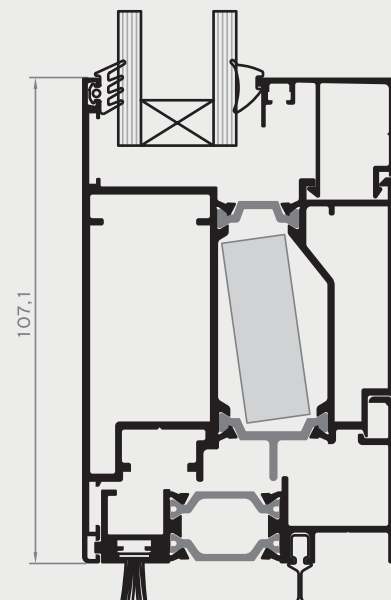
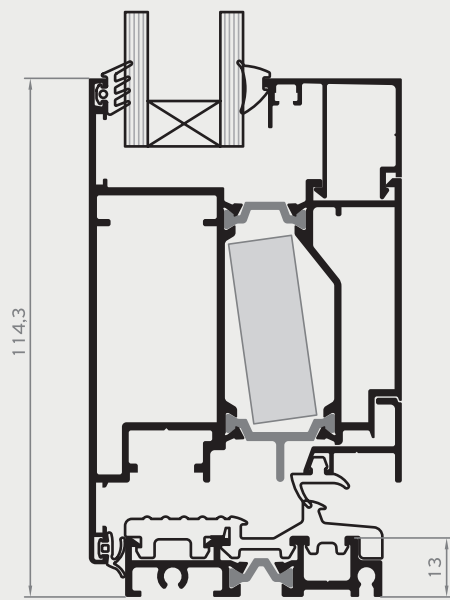
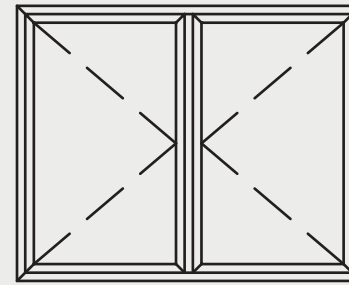

# INSTALLATION

	PRECOMPRESSED MULTI-FUNCTION SEALING TAPE
	BACKER ROD
	HYBRID SEALANT OR NEUTRAL SILICONE
	STYRODUR HIGH DENSITY BOARD
	MARBLE
	POLYURETHANE FOAM
	POLYSTYRENE
	WALL CONSTRUCTION
	WALL FINISH
	REINFORCED CONCRETE
	AIR WATER VAPOR BARRIER TAPE

SIDE SECTION

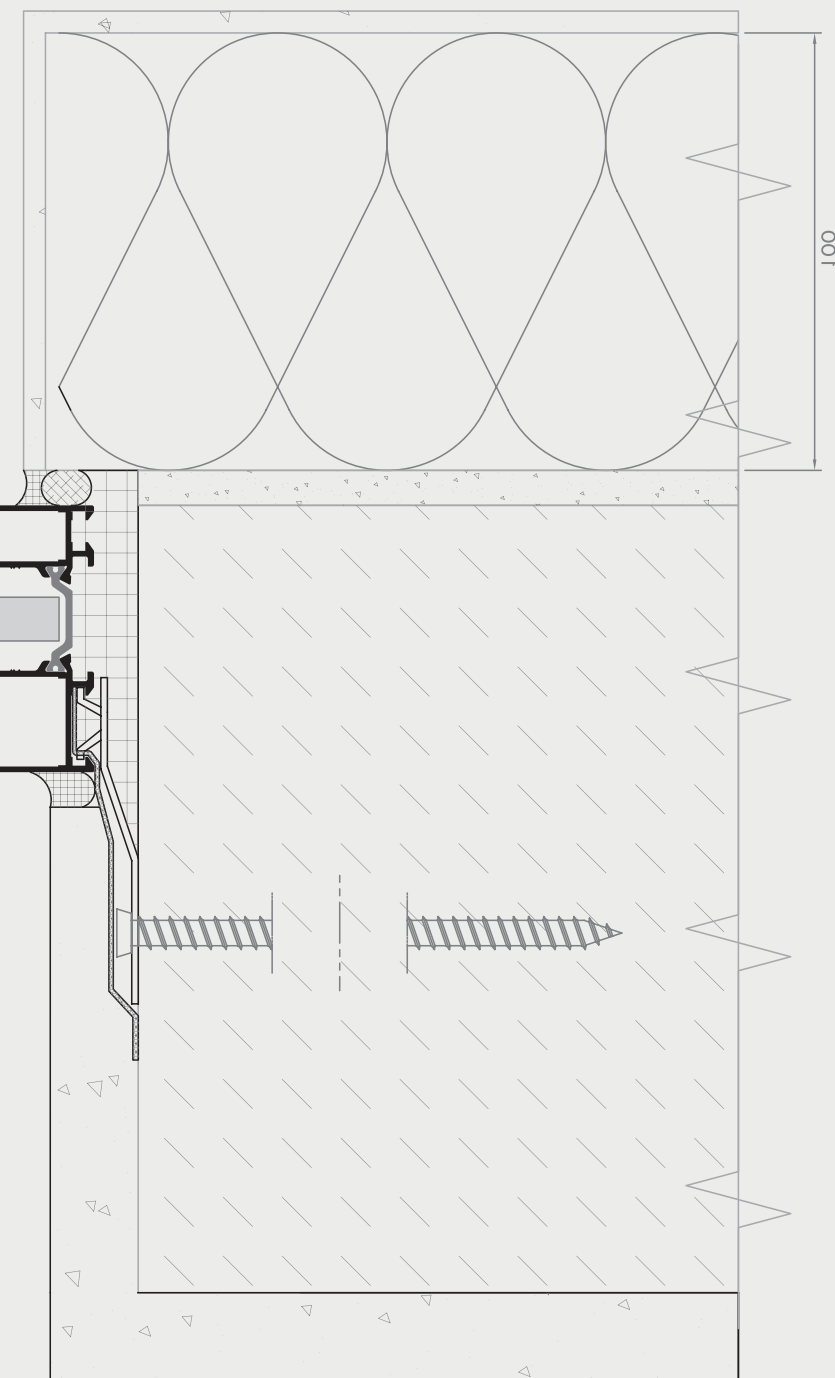

TOP SECTION

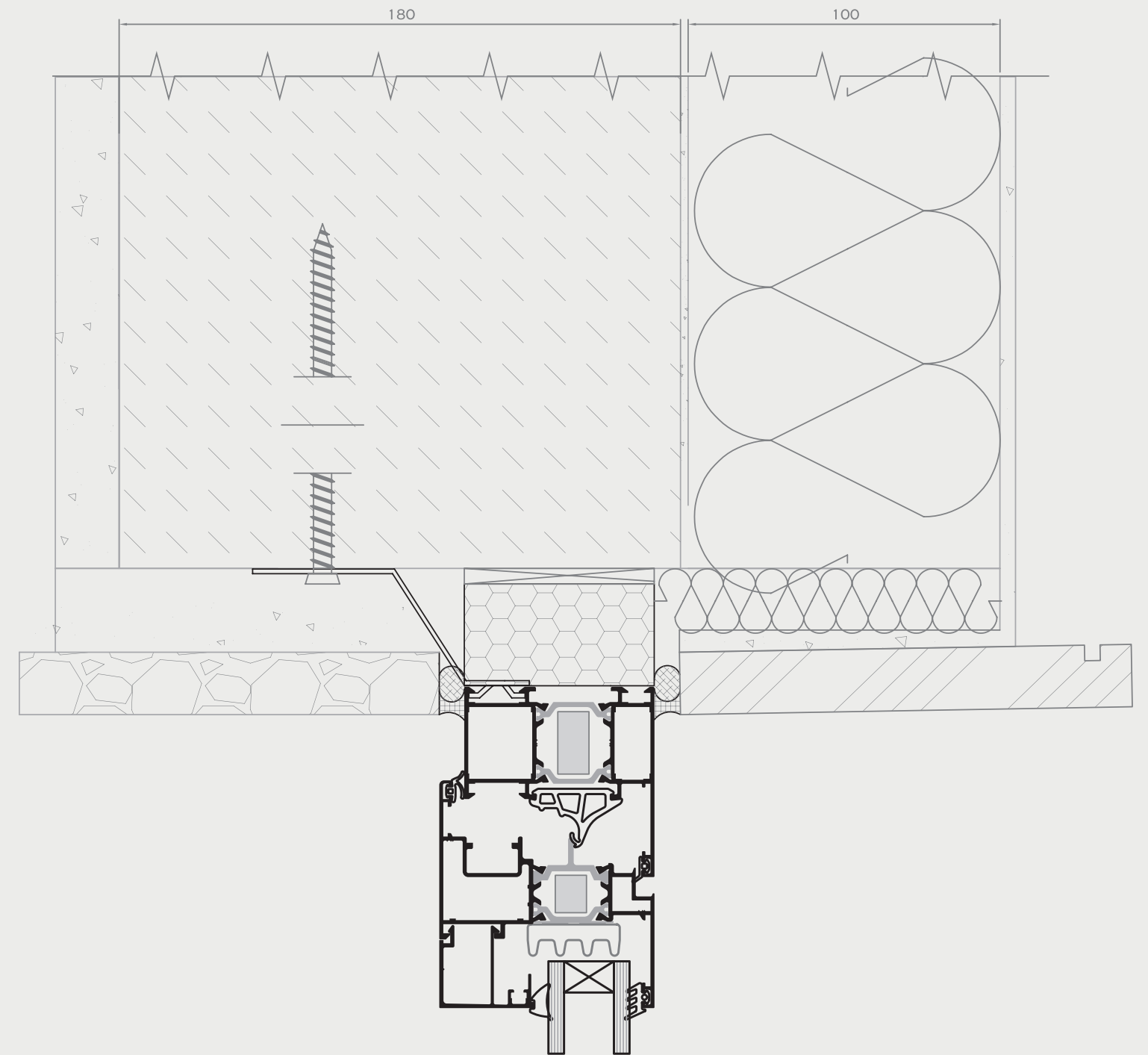

# INSTALLATION

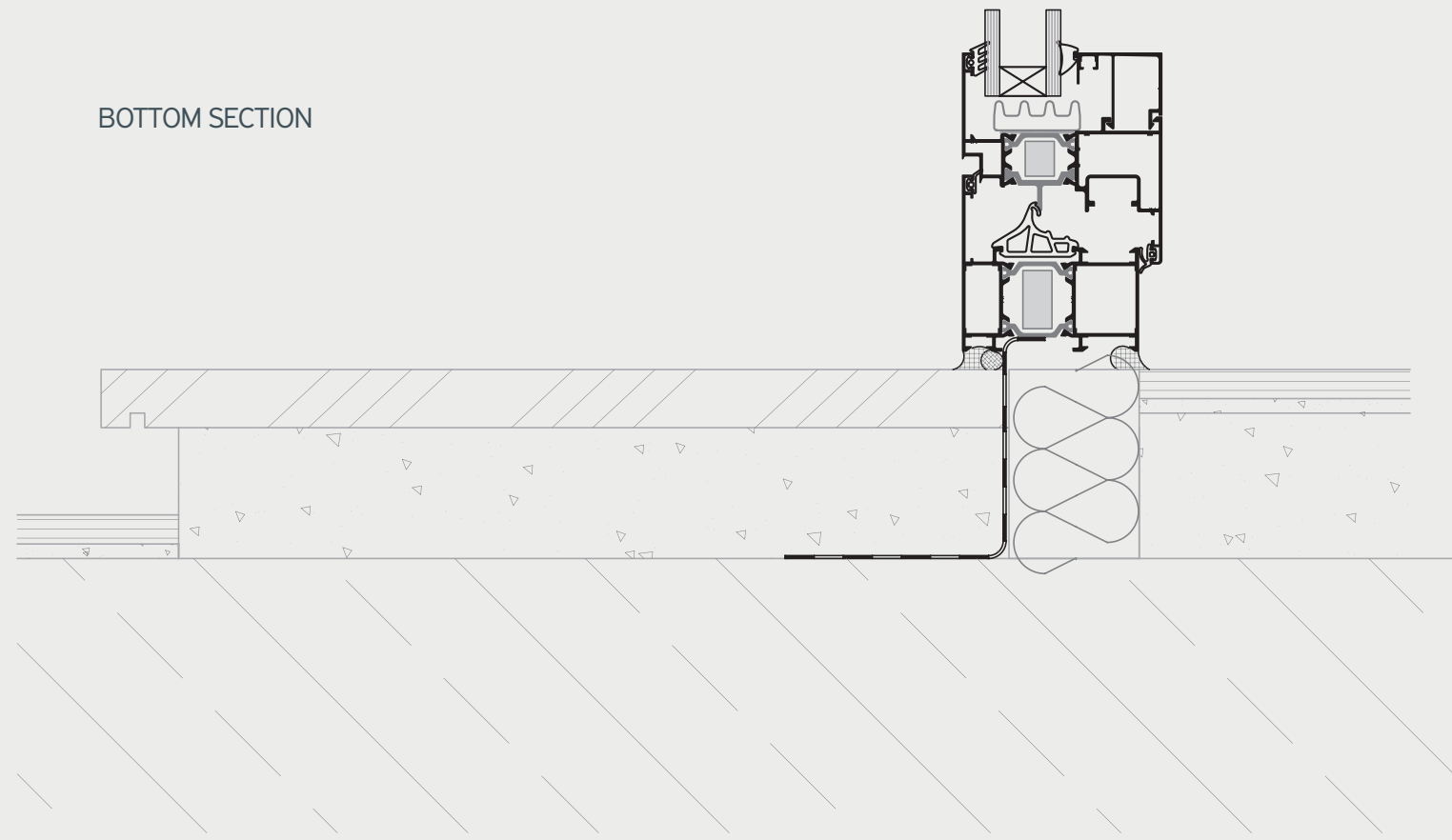

BOTTOM SECTION

# APPLICATIONS

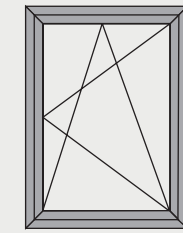

SINGLE TILT & TURN CASEMENT

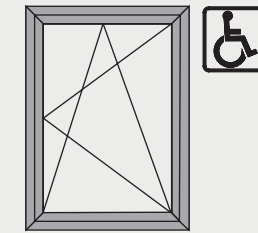

SINGLE TILT & TURN CASEMENT WITH P.W.D. FRAME

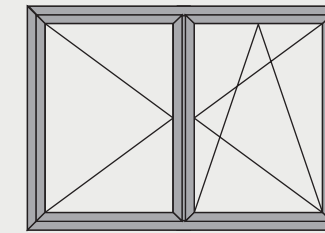

SINGLE TILT & TURN WITH SIDE-HUNG CASEMENT

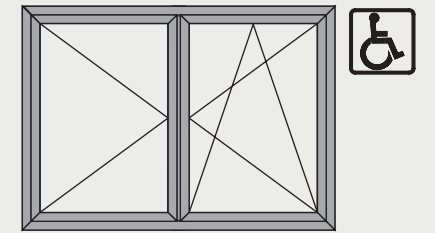

SINGLE TILT & TURN WITH SIDE-HUNG CASEMENT WITH P.W.D. FRAME

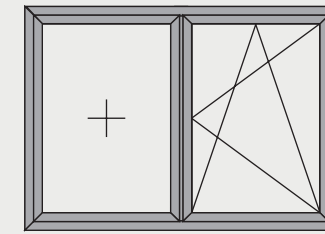

SINGLE TILT & TURN WITH FIXED LIGHT

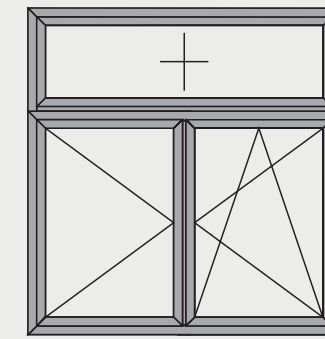

SINGLE TILT & TURN WITH SIDE-HUNG CASEMENT AND FANLIGHT

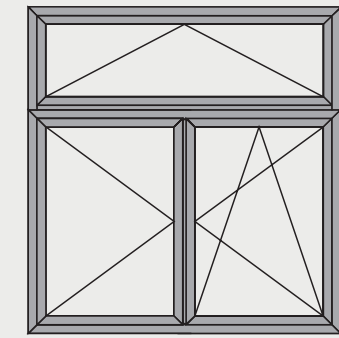

SINGLE TILT & TURN WITH SIDE-HUNG AND BOTTOM HUNG CASEMENT

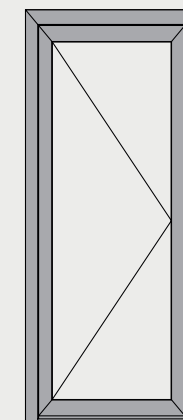

SINGLE LEAF DOOR

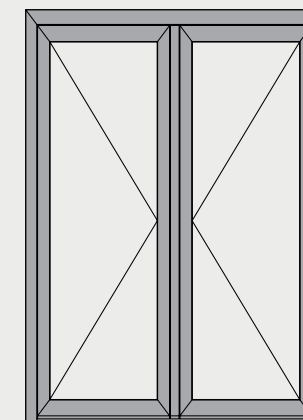

DOUBLE LEAF DOOR

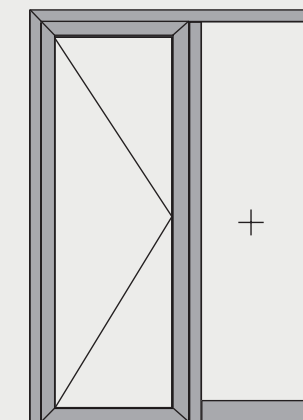

SINGLE LEAF DOOR WITH FIXED LIGHT

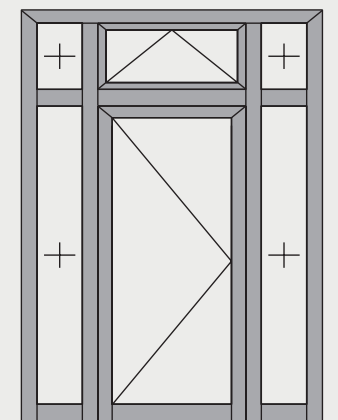

SINGLE LEAF DOOR WITH FANLIGHT AND FIXED LIGHTS

# TABLE OF PERFORMANCE

DISCOVER MORE:



CERTIFICATION	CLASSIFICATION								
<b>WATER TIGHTNESS</b> EN 12208	1A (0 Pa)	2A (50 Pa)	3A (100 Pa)	4A (150 Pa)	5A (200 Pa)	6A (250 Pa)	7A (300 Pa)	8A (450 Pa)	<b>9A (600 Pa)</b>
<b>AIR PERMEABILITY</b> EN 12207	1		2		3		<b>4</b>		
<b>WIND LOAD RESISTANCE</b> MAX TEST PRESSURE EN 12210	1 (400 Pa)	2 (800 Pa)	<b>3 (1200 Pa)</b>		4 (1600 Pa)		5 (2000 Pa)		
<b>WIND LOAD RESISTANCE</b> TO FRONTAL DEFLECTION EN 12210	A (≤ 1/150)			B (≤ 1/200)			<b>C (≤ 1/300)</b>		

THERMAL PERFORMANCE	DIMENSIONS IN MM (W x H)	U <sub>w</sub> in W/m <sup>2</sup> K (U <sub>g</sub> = 1)	U <sub>w</sub> in W/m <sup>2</sup> K (U <sub>g</sub> = 0,7)
1 SASH / STANDARD	900 x 2200	1,69	1,27
1 SASH / ADVANCED	900 x 2200	1,63	1,21
1 SASH / HI	900 x 2200	1,54	1,12
2 SASHES / STANDARD	1500 x 2200	1,74	1,29
2 SASHES / ADVANCED	1500 x 2200	1,67	1,21
2 SASHES / HI	1500 x 2200	1,59	1,15





---

**ALUMIL S.A.  
INDUSTRIAL COMPLEX**

KILKIS INDUSTRIAL AREA  
GR 61 100, KILKIS  
TEL.: +30 23410 79300

**GLOBAL HEADQUARTERS  
& SHOWROOM**

8, GOGOUSI STR, GR 56429  
EFKARPIA, THESSALONIKI  
TEL.: +30 2313 011000

**ATHENS OFFICES & SHOWROOM**

67, TATOIOU AVENUE, GR 13677  
ACHARNES, ATHENS  
TEL.: +30 210 6298100

**[info@alumil.com](mailto:info@alumil.com)**

**[alumil.com](http://alumil.com)**

